

5G N4 Interface Simulation – MAPS™

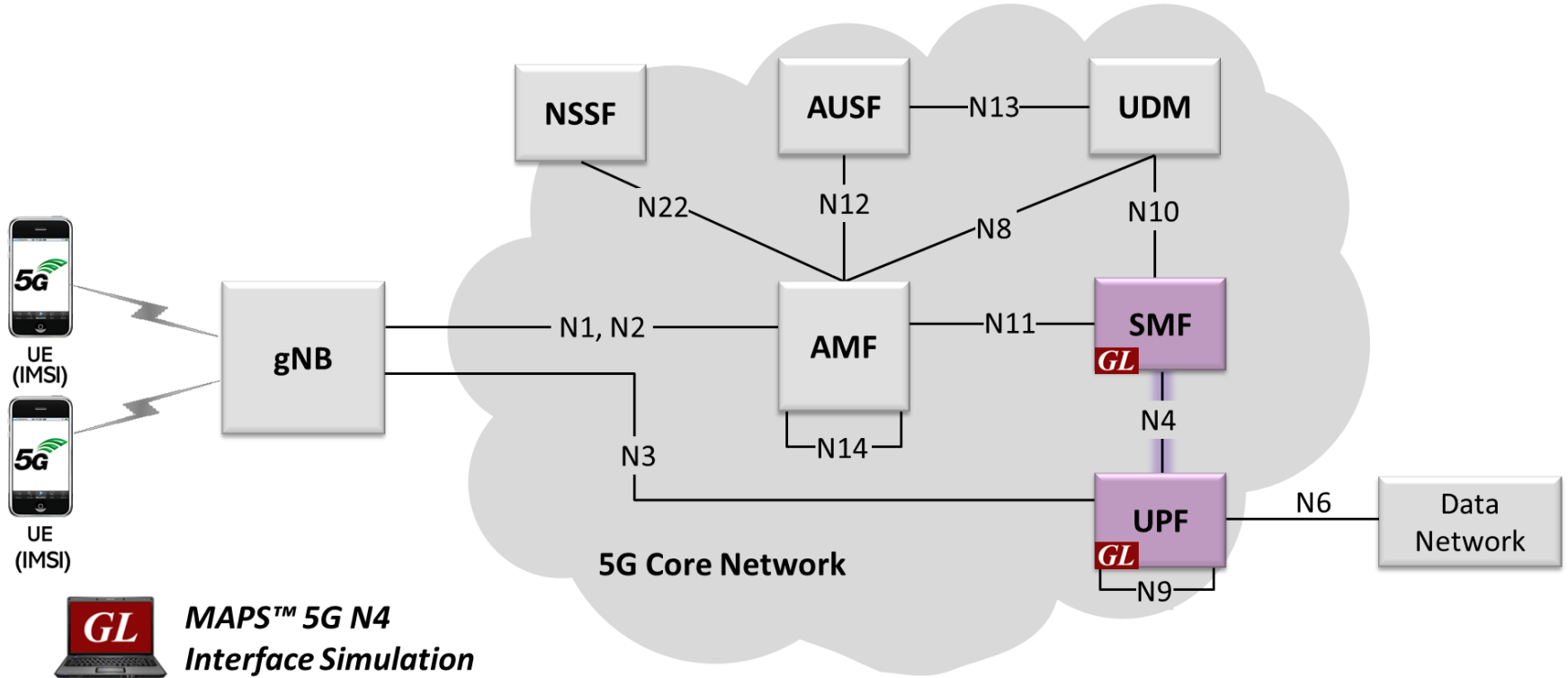

818 West Diamond Avenue - Third Floor, Gaithersburg, MD 20878
Phone: (301) 670-4784 Fax: (301) 670-9187 Email: info@gl.com
Website: <http://www.gl.com>

5G N4 Interface



Features

- Simulates Session Management Function (SMF) and User Plane Function (UPF) elements
- Supports 5G Control plane and User plane
- Supports Mobile Traffic type
- Generates and process PFCP (valid and invalid) messages
- Supports PDU Session Establishment, Modification, Release and Reporting of traffic data usage procedures.
- Supports GTP Traffic (GTP User Plane Data), HTTP traffic generation capability.

Protocol Stack Specification

PFCP
UDP
IP
L2
L1

Supported Protocols	Standard / Specification Used
N4 Interface	
PFCP	3GPP TS 23.501 [28] 3GPP TS 23.502 [29]
UDP	IETF RFC 768
IPv4	IETF RFC 791 [5] IETF RFC 2460 [6]

- PFCP entity supports IPv4 protocol.

5G Call Scenarios

- PFCP Session Establishment Procedure
 - Session Establishment Request
 - Session Establishment Accept
- PFCP Session Modification Procedure
 - Session Modification Request
 - Session Modification Response
- PFCP Session Deletion Procedure
 - Session Deletion Request
 - Session Deletion Response

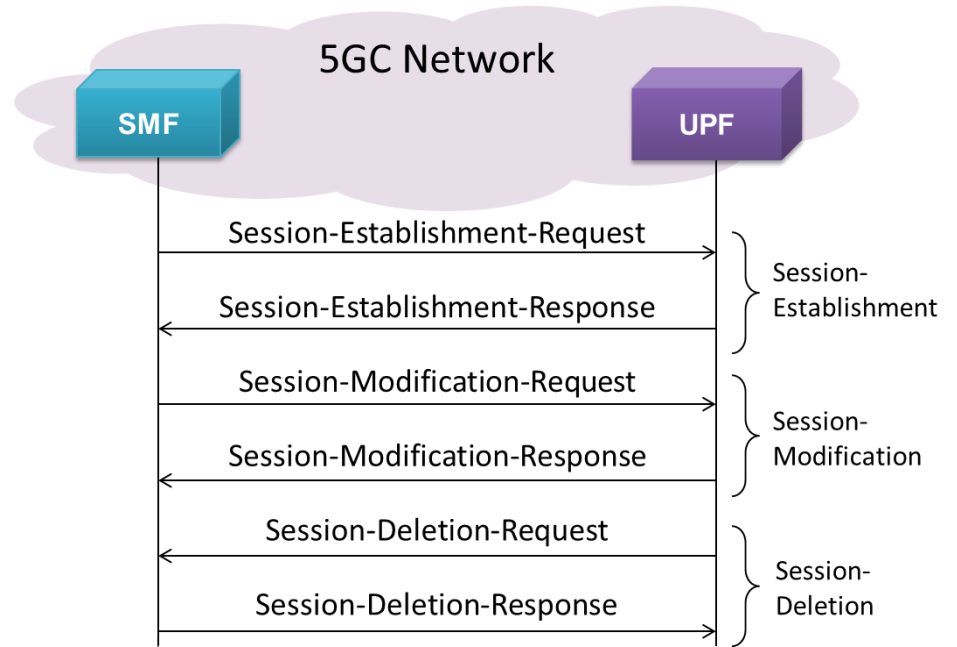

5G N4 Single Interface Testing – Use Cases

UPF Testing

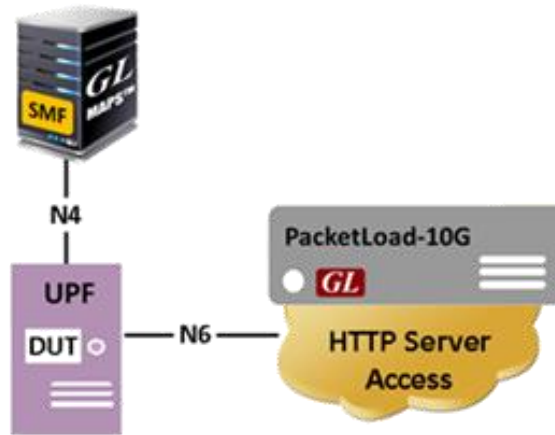

SMF Testing

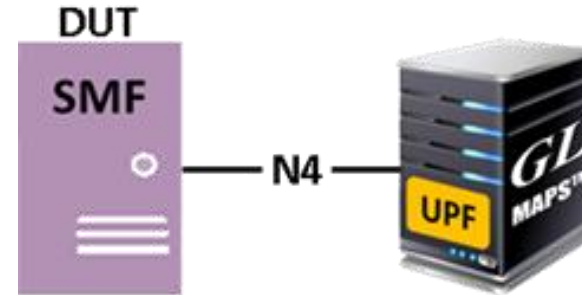

- In SMF Testing, SMF node is the device under test and all the other nodes (AMF, UDM, UPF)UPF node interacting with the SMF node are simulated.
- In UPF Testing, UPF node is the device under test and all the other nodes (gNodeB, SMF, Data Network) SMF node interacting with the UPF node are simulated.

Testbed Configurations

GL MAPS (Message Automation Protocol Simulation) UPF (N4 RELEASE15) - (Testbed Set)

Configurations Emulator Reports Editor Debug Tools Windows Help

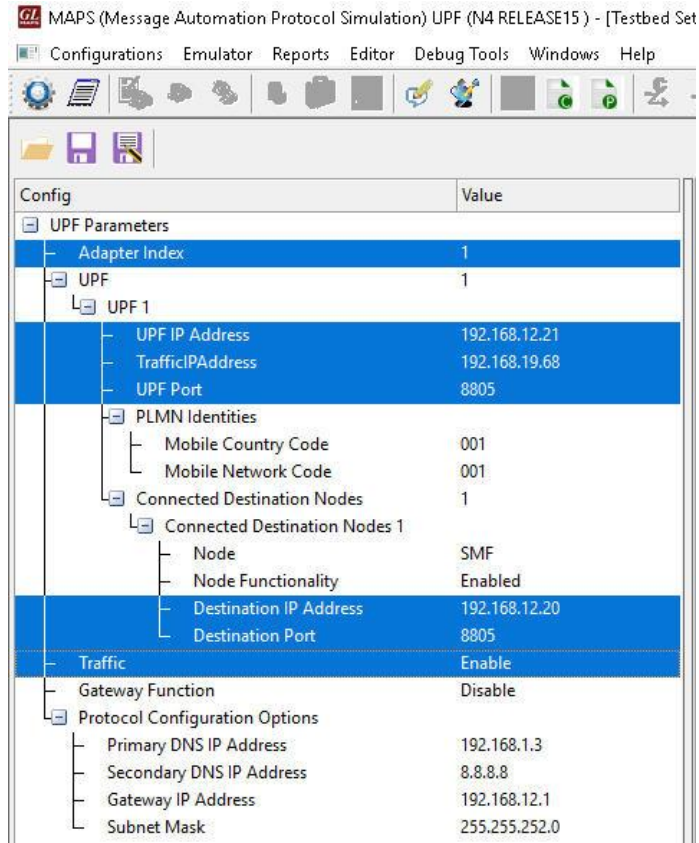

Config	Value
UPF Parameters	
Adapter Index	1
UPF	1
UPF 1	
UPF IP Address	192.168.12.21
TrafficIPAddress	192.168.19.68
UPF Port	8805
PLMN Identities	
Mobile Country Code	001
Mobile Network Code	001
Connected Destination Nodes	1
Connected Destination Nodes 1	
Node	SMF
Node Functionality	Enabled
Destination IP Address	192.168.12.20
Destination Port	8805
Traffic	Enable
Gateway Function	Disable
Protocol Configuration Options	
Primary DNS IP Address	192.168.1.3
Secondary DNS IP Address	8.8.8.8
Gateway IP Address	192.168.12.1
Subnet Mask	255.255.252.0

Profile Configurations

MAPS (Message Automation Protocol Simulation) SMF (N4 RELEASE15) - [Profile Editor - MobileIPCore]

Configurations Emulator Reports Editor Debug Tools Windows Help

#	Profiles (Edit-F2)
1	Profile

Config Value

- Profile
 - Traffic Parameters
 - Mobile Traffic Parameters
 - Udp Src Port: 2152
 - Udp Dst Port: 2152
 - HTTP Server IP Address: 192.168.14.119
 - TCP port for HTTP: 80
 - TCP Connection Identifier: 1
 - Transmission Type: Once
 - Start File Count: 1
 - Traffic File Name: img5a.flixcart.com
 - File Count For Concurrent Or...: 4
 - TxFile For Once Transmission ...: 1
 - File Playback Count: 1

Insert Delete Clear

Global Configuration

Config	Value	<input checked="" type="checkbox"/> Enable
Global Configuration		
Protocol Specific Timer		
T3 Timer in msec	4000	
Call Parameters		
Session Duration in msec	60000	
Inter Call Duratoin in msec	100	
Randomization Parameters		
Enable Randomization in msec	Disable	
Distribution Type	Uniform Distribution	
Minimum Session Duration in msec	10000	
Maximum Session Duration in msec	30000	
Minimum InterCall Duration in msec	1000	
Maximum InterCall Duration in msec	3000	
Path Management Parameters		
Local Restart Counter	1	
Remote Restart Counter	0	
Echo Request Timer in msec	60000	
PacketLoad Configurations		
Traffic Rate	Fixed Bandwidth	
Bandwidth Per User	5.00	
Graph	Enable	
For Random Bandwidth		
Minimum Bandwidth	2.00	
Maximum Bandwidth	15.00	
PCAP File Selection Mode	Dynamic	
HTTP Web Server IPAddress	192.168.114.65	
DNNName	default	

Incoming Call Handler Configuration

The screenshot shows the 'Incoming Call Handlers Configuration' window in the MAPS software. The window title is 'GL MAPS (Message Automation Protocol Simulation) UPF (N4 RELEASE15) - [Incoming Call Handlers Configuration - default]'. The menu bar includes 'Configurations', 'Emulator', 'Reports', 'Editor', 'Debug Tools', 'Windows', and 'Help'. The toolbar contains various icons for file operations and simulation control.

The main configuration area is divided into two tables:

Message Name	Script Name
Session Establishment Request	UPFSessionControl.gls
Association Setup Request	PFCPManagementHandler.gls

Below the tables are 'Add' and 'Delete' buttons.

On the right side, there is a 'Scripts' list containing 'UPFSessionControl.gls'. Below the list are radio buttons for 'Sequence' (selected) and 'Random'. At the bottom right are 'Up' and 'Down' buttons.

Script Editor

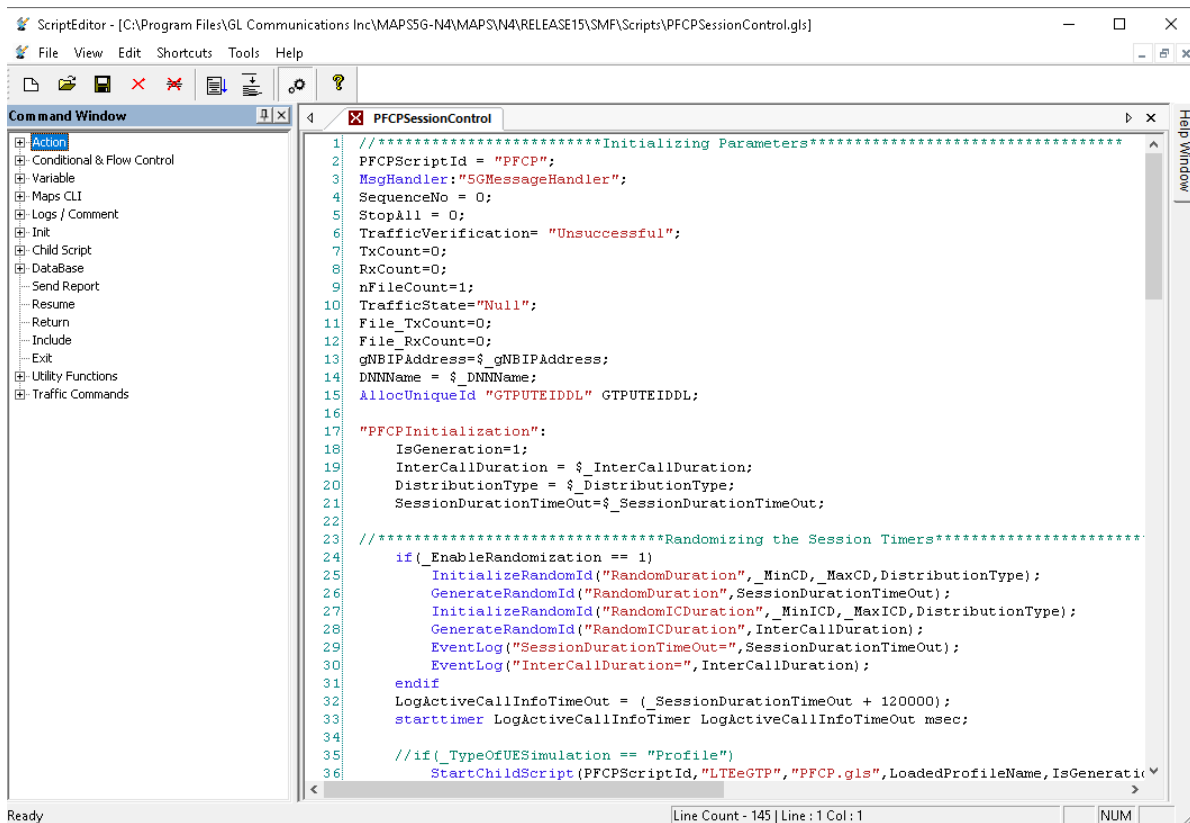

```
ScriptEditor - [C:\Program Files\GL Communications\Inc\MAPS5G-N4\MAPS\N4\RELEASE15\SMF\Scripts\PFPCSessionControl.gls]
File View Edit Shortcuts Tools Help
Command Window
PFCPSessionControl
1 //*****Initializing Parameters*****
2 PFCPScriptId = "PFCP";
3 HsgHandler:"5GMessageHandler";
4 SequenceNo = 0;
5 StopAll = 0;
6 TrafficVerification= "Unsuccessful";
7 TxCount=0;
8 RxCount=0;
9 nFileCount=1;
10 TrafficState="Null";
11 File_TxCount=0;
12 File_RxCount=0;
13 gNBIPAddress=$_gNBIPAddress;
14 DNNName = $_DNNName;
15 AllocUniqueId "GTPUTEIDDL" GTPUTEIDDL;
16
17 "PFCPInitialization":
18   IsGeneration=1;
19   InterCallDuration = $_InterCallDuration;
20   DistributionType = $_DistributionType;
21   SessionDurationTimeOut=$_SessionDurationTimeOut;
22
23 //*****Randomizing the Session Timers*****
24   if( _EnableRandomization == 1)
25     InitializeRandomId("RandomDuration", _MinCD, _MaxCD, DistributionType);
26     GenerateRandomId("RandomDuration", SessionDurationTimeOut);
27     InitializeRandomId("RandomICDuration", _MinICD, _MaxICD, DistributionType);
28     GenerateRandomId("RandomICDuration", InterCallDuration);
29     EventLog("SessionDurationTimeOut=", SessionDurationTimeOut);
30     EventLog("InterCallDuration=", InterCallDuration);
31   endif
32   LogActiveCallInfoTimeOut = (_SessionDurationTimeOut + 120000);
33   starttimer LogActiveCallInfoTimer LogActiveCallInfoTimeOut msec;
34
35 //if(_TypeOfUESimulation == "Profile")
36   StartChildScript(PFCPScriptId, "LTEeGTP", "PFCP.gls", LoadedProfileName, IsGenerati...
```

Ready Line Count - 145 | Line : 1 Col : 1 NUM

Message Editor

The screenshot displays the Message Editor application window. The title bar reads "Message Editor - Untitled". The menu bar includes "File", "View", "Direction", "Tools", and "Help". Below the menu bar is a toolbar with icons for help, save, and close. The main interface is divided into three sections:

- Left Panel:** A tree view showing the message structure. The root is "PFPC", which contains "S" (Session), "Message Priority", "Version", "Message Type", "Length", "Session Endpoint Identifier", "Sequence Number", "Message Priority", "InformationElements", and "Update PDR". Under "InformationElements", there is an "Information Element Id" element.
- Right Panel:** A dropdown menu showing a list of message types and their corresponding session IDs. The selected item is "Session Establishment Request = 50". Other items include "Session Modification Request = 52", "Session Establishment Response = 51", "Session Modification Response = 53", "Session Deletion Request = 54", "Session Deletion Response = 55", "Session Report Request = 56", and "Session Report Response = 57".
- Main Area:** A hex dump of the message content. The dump starts with "==== PFPC Layer =====" and shows the following fields and their values:
 - 0000 S =1 SEID field is present
 - 0000 Message Priority: =1. Present
 - 0000 Spare = ...000.. (0)
 - 0000 Version = 001..... PFCP Version 1
 - 0001 Message Type = 00110100 Session Modification Request
 - 0002 Length = 44 (x002C)
 - 0004 Session Endpoint Identifier = x0000000000000000
 - 000C Sequence Number = 0 (x000000)
 - 000F Spare = ...0000 (0)
 - 000F Message Priority = 0000.... (0)
 - Update PDR =
 - 0010 Information Element Id = x0009 Update PDR
 - 0012 Length = 28 (x001C)
 - PDR ID =
 - Information Element Id = x0038 Packet Detection Rule ID
 - Length = 2 (x0002)
 - Rule ID = 0 (x0000)
 - PDI =
 - 001A Information Element Id = x0002 PDI
 - 001C Length = 18 (x0012)
 - Source Interface =
 - Information Element Id = x0014 Source Interface
 - Length = 1 (x0001)
 - Interface value = ...0000 Access

The status bar at the bottom shows "Ready" on the left and "NUM" on the right.

5G N4 Interface – Call Simulation

Call Generation

Call Reception

MAPS (Message Automation Protocol Simulation) SMF (N4 RELEASE15) - [Call Generation]

Configurations Emulator Reports Editor Debug Tools Windows Help

Sl No	Script Name	Profile	Call Info	Script Execution	Status	Events	Events Profile	Result	Total Iterations	Completed Iterations
2	PFCPSessionControl.gls			Start	SESSION-TERMINATED	None	None	Pass	1	1
3	PFCPSessionControl.gls			Start		None	None	Unknown	1	0
4	PFCPManagementPr...			Start		None	None	Unknown	1	0
5	PFCPSessionControl.gls			Start		None	None	Unknown	1	0
6	PFCPSessionControl.gls			Start		None	None	Unknown	1	0
7	PFCPSessionControl.gls			Start		None	None	Unknown	1	0

Add Delete Insert Refresh Start Start All Stop Stop All Abort Abort All

Save Column Width Show Latest

SMF UPF

Session Establishment Request 16:31:05.005000

Session Establishment Response 16:31:05.011000

Session Modification Request 16:31:05.011000

Session Modification Response 16:31:05.017000

Session Deletion Request 16:31:17.410000

Session Deletion Response 16:31:17.416000

Find

```

***** PFCP Layer *****
0000 S = .....1 SEID f
0000 Message Priority: = .....1. Pres
0000 Spare = .....000... (0)
0000 Version = 001..... PFCP V
0001 Message Type = 00110010 Sessio
0002 Length = 129 (x0081)
0004 Session Endpoint Identifier = x00000000000000C
000C Sequence Number = 0 (x000000)
000F Spare = .....0000 (0)
000F Message Priority = 0000..... (0)
0010 Information Element Id = x003C Node ID
0012 Length = 5 (x0005)
0014 Node ID Type = ...0000 IPv4 s
0014 Spare = 0000... (0)
0015 IPv4 Address = 192.168.1.27 (x
CP F-SEID
Information Element Id = x0039 F-SEID
Length = 13 (x000B)
V6 = .....0 Not Pr
V4 = .....1. Preser
    
```

Scripts Message Sequence Event Config Script Flow

Initialisation Errors Error Events Captured Errors Link Status: Up=0 Down=0

MAPS (Message Automation Protocol Simulation) UPF (N4 RELEASE15) - [Call Reception]

Configurations Emulator Reports Editor Debug Tools Windows Help

Sl No	Script Name	Profile	Call Info	Script Execution	Status	Events	Events Profile	Results
1	GTPSessionInit.gls		0	Stop	GTP User Session Started	StopGTP Session		Unknown
2	PFCPManagementHandles.gls			Stop		None		Fail
3	UPFSessionControl.gls			Completed	GTP-U Mobile-Traffic State	None		Unknown

Stop Stop All Abort Abort All Show Records Select Active Call Auto Trash Trash

Save Column Width Show Latest

DUT MAPS

Session Establishment Request 16:44:30.032000

Session Establishment Response 16:44:30.033000

Session Modification Request 16:44:30.039000

Session Modification Response 16:44:30.039000

Session Deletion Request 16:44:48.626000

Session Deletion Response 16:44:48.626000

Find

```

***** PFCP Layer *****
0000 S = .....1 SEID f
0000 Message Priority: = .....1. Pres
0000 Spare = .....000... (0)
0000 Version = 001..... PFCI
0001 Message Type = 00110010 Sess
0002 Length = 129 (x0081)
0004 Session Endpoint Identifier = x00000000000000C
000C Sequence Number = 0 (x000000)
000F Spare = .....0000 (0)
000F Message Priority = 0000..... (0)
0010 Information Element Id = x003C Node ID
0012 Length = 5 (x0005)
0014 Node ID Type = ...0000 IPv4
0014 Spare = 0000... (0)
0015 IPv4 Address = 192.168.1.27
CP F-SEID
Information Element Id = x0039 F-SEID
Length = 13 (x000B)
V6 = .....0 Not Pr
V4 = .....1. Preser
    
```

Scripts Message Sequence Event Config Script Flow

Initialisation Errors Error Events Captured Errors Link Status: Up=0 Down=0

Load Generation

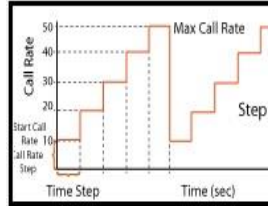
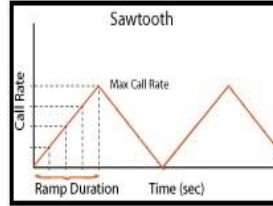
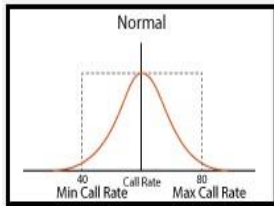
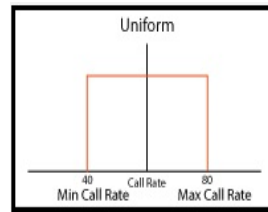
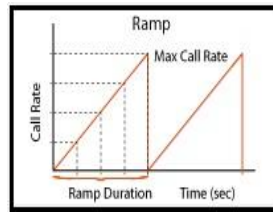
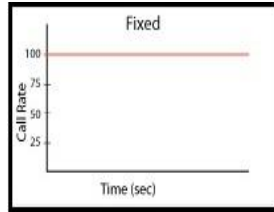

MAPS (Message Automation Protocol Simulation) SMF (N4 RELEASE15) - [Load Generation - LoadGendefault]

Configurations Emulator Reports Editor Debug Tools Windows Help

Total Calls To Generate 100 (* indicates no limit)

Max Active Calls 100 Unique Distributions Per Script

Multi Distributions

Distributions	Description	Add
Uniform	MinCR=40, MaxCR=80, Duration=10	Remove
Fixed	Call Rate=200, Duration=10	Remove All
Normal	MinCR=40, MaxCR=80, Duration=10	Edit

Scripts

Scripts	Profile	Exclusive Profiles
PFPCSessionControl		

Add Delete Add Delete

Stop Time

Days 0 Hours 0 Minutes 0

Start Time - 00:00:00.000 Pause

End Time - 00:00:00.000 Start

Initialization Errors Error Events Captured Errors Link

- Stability/Stress and Performance testing using Load Generation
- Different types of Load patterns to distribute load
- User can load multiple patterns for selected script
- User configurable Test Duration, CPS, Maximum and Minimum Call Rate etc

Traffic Simulation

"All Interfaces"



"All Protocols"



Scales up to 100K to 200K Sustained Calls



Remote Scripting and
Client Access

"Large Capacities"

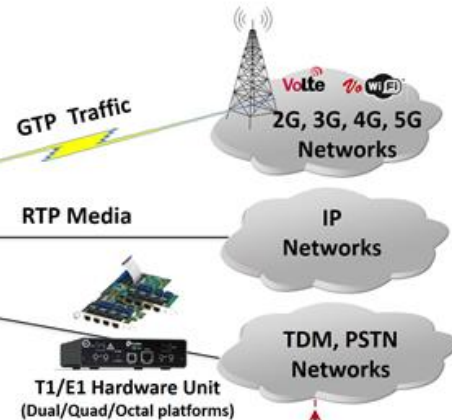

- Voice Files (wav, pcm, GL's Proprietary GLW)
- Video Trace Files (hdl - GL's Proprietary format)
- DTMF and MF Digits
- Tones (single, dual and user-defined)
- Industry Standard Codecs (a-law, u-law, gsm and more)
- FAX (T.30 RTP pass-through and T.38 UDPTL)
- Impairments (Latency, Packet Loss, Packet Effects)
- Mobile Data, Packet, GTP Gateway Traffic

THANK YOU