

# SonetExpert™ Unchannelized Analyzer

(OC-3 / STM-1, OC-12 / STM-4, OC-48/STM-16 and OC-192/STM-64)

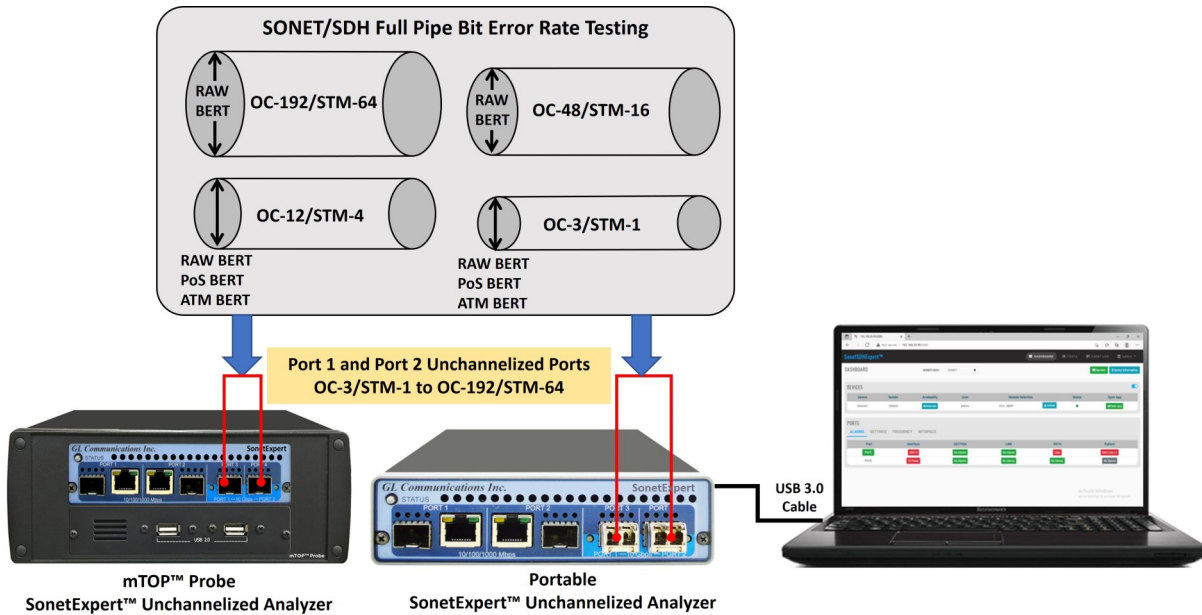

## Overview

A majority of the backbone transport for voice, video and data applications continues to be SONET and SDH optical transmission networks. SONET and SDH transmission network also continue to be used for conventional channelized traffic – carrying many TDM T1, E1, T3, and E3 pipes.

GL's SonetExpert™ portable hardware and application supports SONET/SDH Emulation and Analysis:

- SonetExpert™ Channelized Emulation/Analysis for OC-3/12, STM-1/4 (for more details, refer to **SonetExpert-Channelized-Analyzer-Brochure**)
- SonetExpert™ Unchannelized Emulation/Analysis for OC-3/STM-1 to OC-192/STM-64

GL's SonetExpert™ Unchannelized Analyzer is capable of SONET/SDH testing over OC-3/STM-1, OC-12/STM-4, OC-48/STM-16 and OC-192/STM-64 transports. It is based on the PacketExpert™/SonetExpert™ hardware platform. PacketExpert™/SonetExpert™ hardware platform is a versatile hardware platform that supports both Ethernet (up to 10G) and SONET/SDH (up to OC-192/STM-64) testing. Two ports support SONET/SDH testing. Multiple hardware units can be connected to a single PC to increase test port density. The hardware/software is controlled through a web interface, and is accessed using any browser running on any device like PC, Laptop, Tablet etc. Unchannelized Analyzer supports RAW format BERT up to OC-192/STM-64 and various applications for OC-3/STM-1 and OC-12/STM-4 ATM (Asynchronous Transfer Mode) and PoS (Packet over SONET).

The ATM Analyzer is used to analyze and decode different ATM protocols like RAW ATM cells, AAL2 Protocols (CPS-SDU, SSSAR-SDU, and SSCS), AAL5 (CPCS), UNI and others across U plane and C plane of UNI and NNI interface. The analyzer can also decode ATM frames constituting Classical IP over ATM and traditional SS7 Stack (ISUP, SCCP, MAP, CAMEL(CAP) etc.) over ATM.

The PoS Analyzer captures a host of PoS protocols exchanged between the two nodes over SONET and provides useful analysis, which includes distribution of protocols, protocol fields, frame lengths, and frame status.

Various platforms are offered, including a [High-Density mTOP™](#) 1U/2U rack mount enclosures within which multiple SonetExpert™ hardware units are stacked to provide high density form factor solution for testing multiple SONET/SDH lines.

GL also offers stand-alone [mTOP™ Probe](#) hardware variant of SonetExpert™, where a SonetExpert™ hardware unit is coupled with a built in SBC (Single Board Computer), to make it a compact, portable tool, ideal for field testing.

More details are provided below, and visit at [SonetExpert™ Unchannelized Analyzer](#) webpage.



818 West Diamond Avenue - Third Floor, Gaithersburg, MD 20878, U.S.A  
(Web) [www.gl.com](http://www.gl.com) - (V) +1-301-670-4784 (F) +1-301-670-9187 - (E-Mail) [info@gl.com](mailto:info@gl.com)

## Main Features

Bit Error Rate testing (BERT):	<ul style="list-style-type: none"> <li>• SonetExpert™ can perform Unchannelized BER Testing over OC-3/STM-1, OC-12/STM-4, OC-48/STM-16 and OC-192/STM-64 SONET/SDH rates. It treats the entire OC-3 to OC-192 as a single big pipe and transmits/analyzes BERT traffic as a whole for the entire pipe i.e. using concatenated STS-3c/STS-12c/STS-48c/STS-192c signals. This helps to test and qualify the entire SONET/SDH Pipe, before delving into smaller pipes carried within</li> <li>• Also supports BERT over PoS and ATM payloads on OC-3/STM-1 and OC-12/STM-4</li> </ul>
Alarms/Error Monitoring:	<ul style="list-style-type: none"> <li>• GL's SonetExpert™ application monitors and reports various SONET/SDH Alarms (Section/Path/Line as well as BERT Alarms) in real time</li> <li>• Alarms are also plotted in a graph and up to 7 days of alarm data can be viewed in the graph. Alarm generation and Error insertion also supported</li> <li>• Supports Loss of Signal and Loss of Frames hardware alarms indication</li> </ul>
Protocol Analysis	<ul style="list-style-type: none"> <li>• PoS/ATM/RAW captured traffic can be analyzed in real time (for OC-3/STM-1 and OC-12/STM-4)</li> <li>• Protocol Analysis provides detailed analysis of higher layer protocols (for PoS and ATM) and decode of SONET/SDH frames in real time on both ports simultaneously</li> </ul>
Record and Playback	<ul style="list-style-type: none"> <li>• SonetExpert™ supports capturing wirespeed traffic (for OC-3/STM-1 and OC-12/STM-4) traffic on two ports simultaneously to a file on hard disk, with hardware filtering and timestamping</li> <li>• The captured traffic can be played back from file on both ports simultaneously</li> <li>• In PoS mode, PPP packets are captured, in ATM mode ATM cells are captured, and in RAW mode, RAW SONET/SDH frames are captured</li> <li>• Similarly for playback, PPP packets/ATM cells/RAW SONET/SDH frames can be played back on a single port or on both ports</li> </ul>
SCAN incoming SONET/SDH traffic and identify the traffic structure	<ul style="list-style-type: none"> <li>• Scans the incoming traffic on SONET/SDH interfaces, identifies and displays the traffic structure</li> <li>• SCAN application supported on OC-3/STM-1, OC-12/STM-4, OC-48/STM-16 and OC-192/STM-64 rates</li> <li>• Traffic structure up to STS-3c is identified and displayed in the main display, with different colors clearly indicating equipped or unequipped channels</li> <li>• Provides complete overview of the incoming SONET/SDH traffic in an easy and intuitive graphical display and helps technicians to quickly identify the structure of unknown SONET/SDH traffic</li> <li>• User selectable SONET or SDH terminology supported on both the ports independently.</li> </ul>
Web based software	<ul style="list-style-type: none"> <li>• Software is provided as a web interface, accessed from any standard web browser, allowing access from different devices like PCs/Laptops/Tablets etc. and also from different operating systems like Windows®/Linux®/Android® etc.</li> <li>• The web interface enables multiple users to connect to a single web server and independently run tests on different hardware units. Using the mTOP™ probe unit to run the web server facilitates portable field testing, allowing users to access the software features using a Tablet running a browser</li> </ul>

## Web Interface

SonetExpert™ Unchannelized software is provided in the form of an easy to use and intuitive web interface. All the functionalities can be accessed from any standard web browser. This makes it convenient to control the hardware from multiple locations and from multiple access devices like a PC, laptop and even a tablet. Also, the client machine can be any operating systems such as Windows®/ Linux®/Android® etc. as long as web browser can run on it.

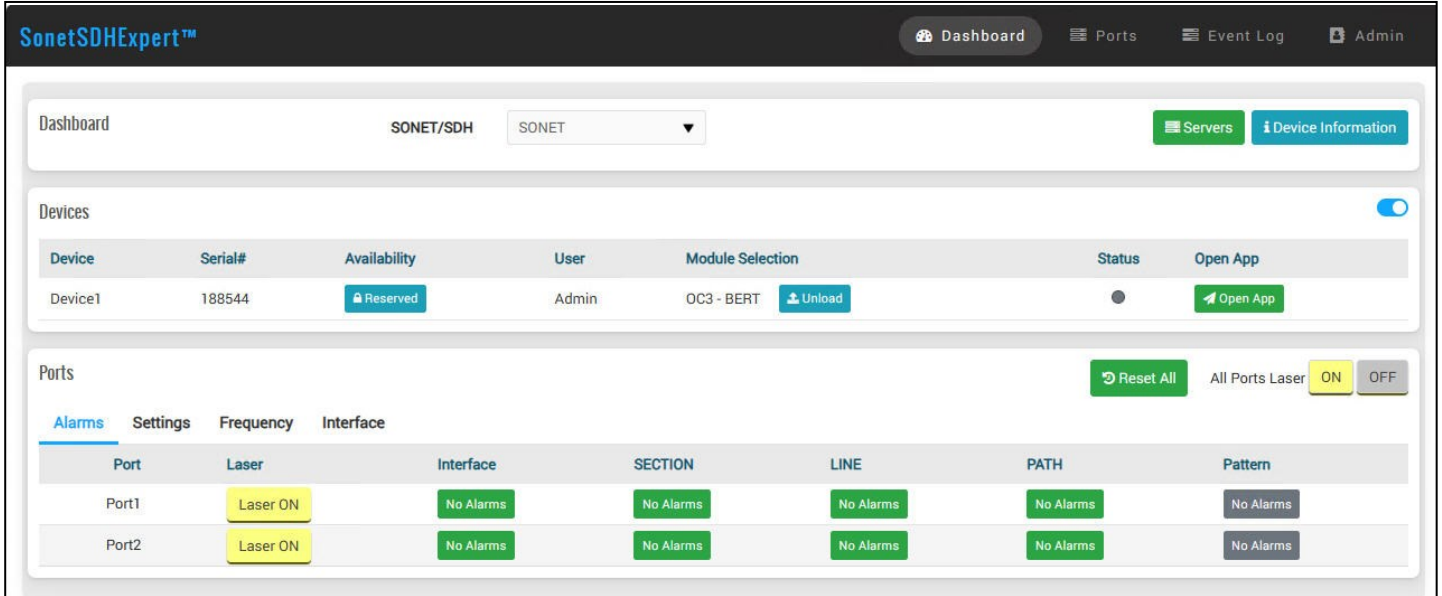

Figure: SonetExpert™ Unchannelized Analyzer Web Interface

## Bit Error Rate (BER) Testing

### BERT:

- BERT over RAW SONET/SDH supported over OC-3/STM-1, OC-12/STM-4, OC-48/STM-16 and OC-192/STM-64
- BERT over PoS supported over OC-3/STM-1 and OC-12/STM-4
- BERT over ATM supported over OC-3/STM-1 and OC-12/STM-4

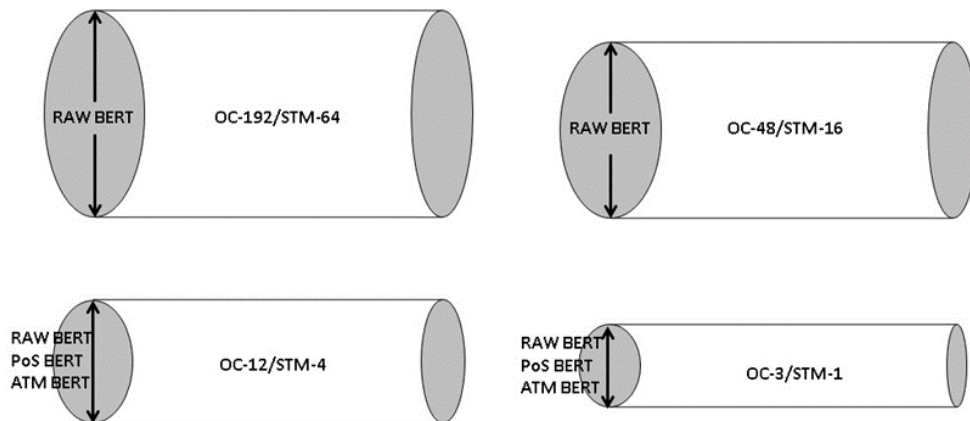

Figure: Whole Pipe Testing

## Bit Error Rate (BER) Testing (Contd.)

- BERT testing can be done on 2 ports simultaneously
- Industry standard PRBS patterns supported -  $2^9-1$ ,  $2^{11}-1$ ,  $2^{15}-1$ ,  $2^{20}-1$ ,  $2^{23}-1$ ,  $2^{29}-1$ ,  $2^{31}-1$
- Reports Pattern Sync loss count and seconds, Bit Error Rate/count and seconds, Error/Error free seconds
- Bit Error and Sync Loss Alarms are displayed along with other alarms for comprehensive alarm monitoring in a single screen

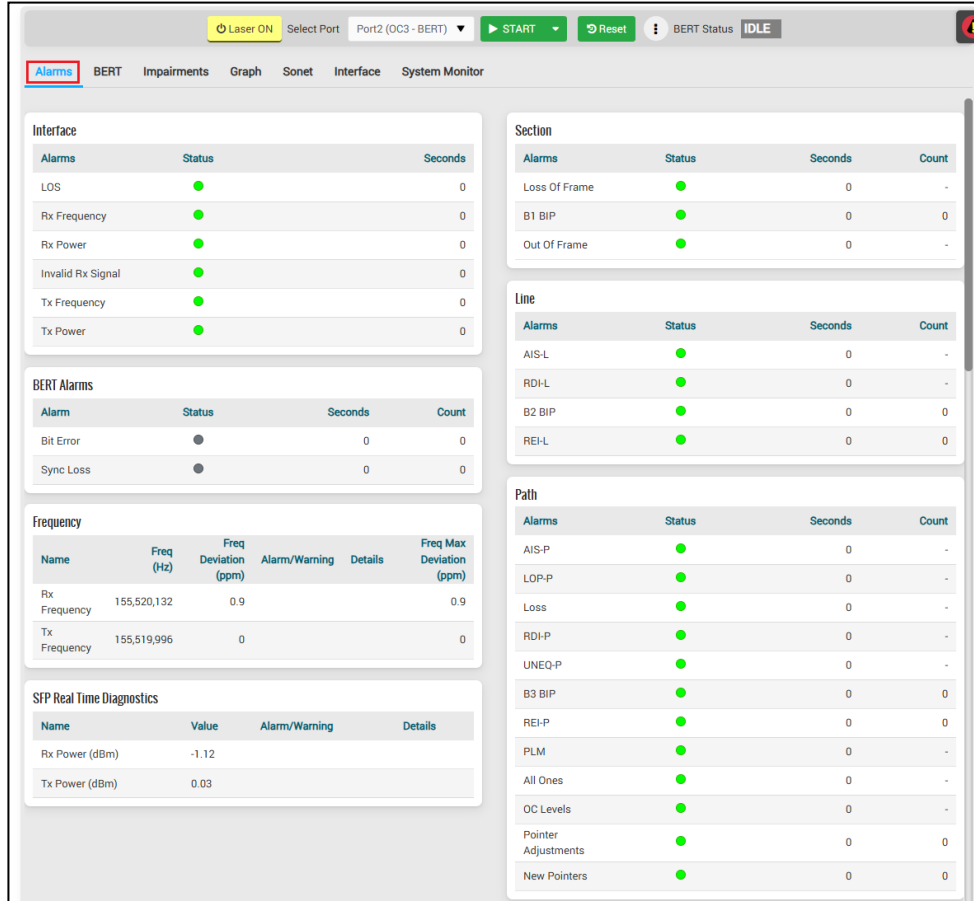

Figure: All Alarms

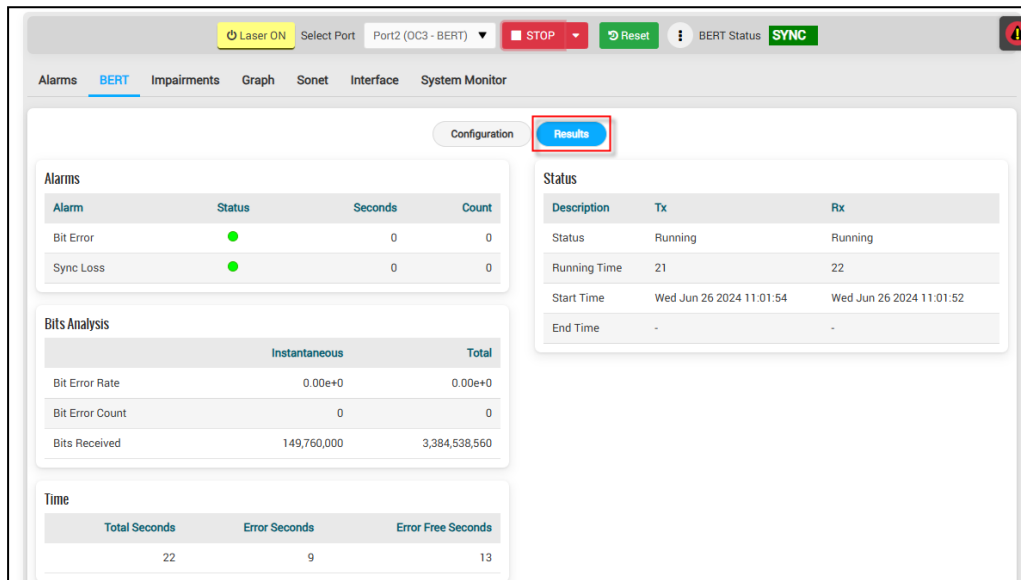

Figure: BERT Results

# Bit Error Rate (BERT) Testing (Contd.)

## Graph:

- All SONET/SDH alarms, Interface related alarms like Tx/Rx Frequency, Power, Sync Loss, and Bit Error events are plotted in a real time “Event Graph”
- Events are grouped into major groups and plotted in the graph. For example, Bit Error and Sync loss events are grouped under Bert group, all Path alarms under Path group, all Line alarms under Line group, all Section alarms under Section group, all Interface related alarms under Interface group. User can click any event plotted on the graph, and the details of all the alarms present for the event will be displayed next to the graph including all the alarms present within each group

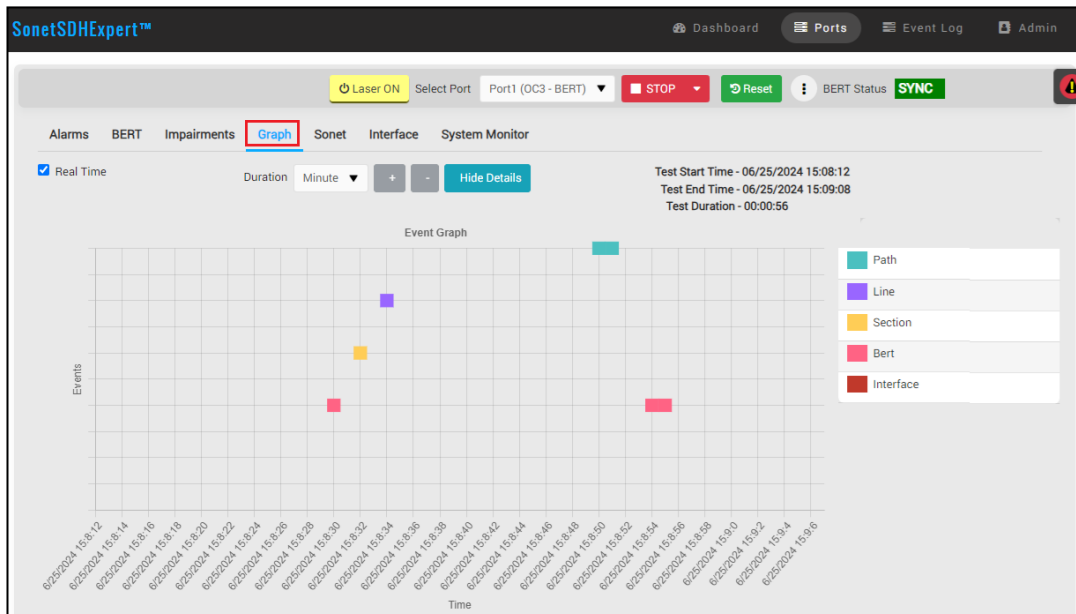

Figure: BERT Graph

- Up to 7 days of history data for all events are available in the graph and can be drilled down to the second level
- Minute/Hour/Day/7 days views available. User can switch between views anytime. At larger time scales, the results are summarized over appropriate time periods for easy event viewing

## Impairment Generation:

- Alarm generation – generate LOF, AIS-L, RDI-L, AIS-P, LOP-P, RDI-P, UNEQ-P alarms
- Error Insertion – insert B1/B2/B3, REI-L, REI-P errors – both Single as well as rate ( $10^{-4}$  to  $10^{-9}$ )
- Bit error insertion – insert Single as well as Rate bit errors rate ( $10^{-3}$  to  $10^{-9}$ )

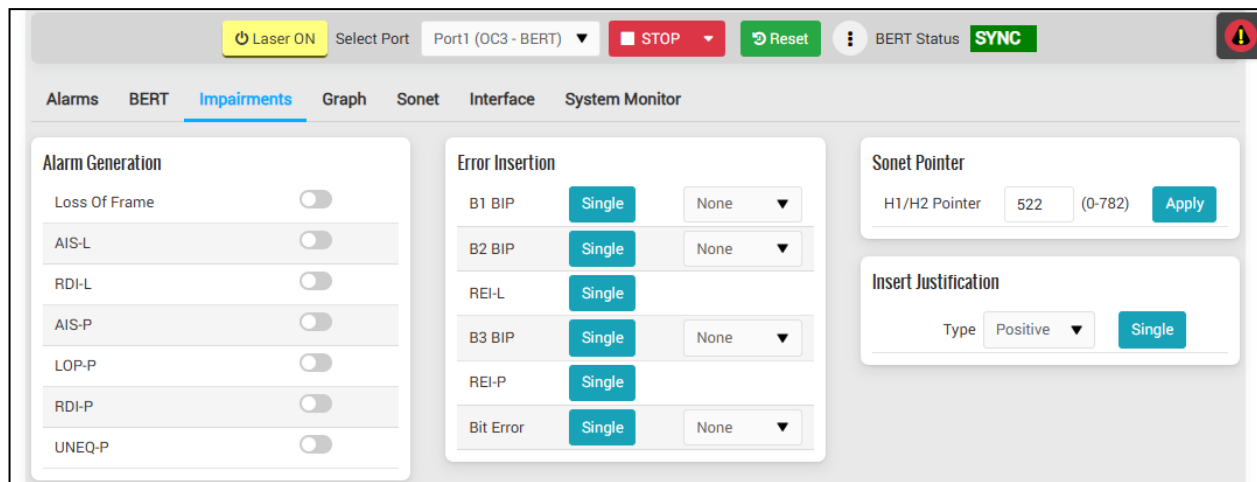

Figure: BERT Impairments

## Bit Error Rate (BERT) Testing (Contd.)

### PoS and ATM BERT:

- User defined PoS Header fields – user can define various IP/UDP fields like Source/Destination IP Addresses/ UDP ports etc.

The screenshot shows a configuration window for PoS Header Fields. It is divided into three main sections: Header Configuration, Payload Configuration, and Frame Size and Rate. The Header Configuration section includes fields for Source IP Address (192.168.1.100), Destination IP Address (192.168.1.200), TOS/DS (0), TTL (128), Protocol (17 UDP), Header Checksum (00-00, Auto Compute), Identification (00-00, Auto Increment), and UDP Source/destination ports (1000 and 2000). The Payload Configuration section has a Pattern Type dropdown set to PRBS\_2E9\_1. The Frame Size and Rate section shows an IP Frame Size of 1518 and a Rate of 100%.

Figure: PoS Header Fields

- User defined ATM Header fields – user can define various ATM header fields like UNI/NNI choice, GFC, VPI/VCI etc.

The screenshot shows a configuration window for ATM Header Fields. It includes sections for ATM Header Fields, Payload Configuration, and Traffic Rate. The ATM Header Fields section has radio buttons for User/Network Interface (UNI selected), Generic Flow Control (1), Virtual Path Identifier (2), Virtual Channel Identifier (3), Payload Type (1), and Cell Loss Priority (1). The Payload Configuration section has a Pattern Type dropdown set to PRBS\_2E9\_1. The Traffic Rate section has a Bandwidth Type dropdown set to Cell Ratio, Traffic Cells (3), and Idle Cells (3).

Figure: ATM Header Fields

## Alarms/Error Monitoring

- Monitors and reports all SONET/SDH alarms - Section, Line, Path alarms (SONET) or RSOH, MSOH, HP alarms (SDH)

### Section/RSOH Alarms

SONET (Section)	SDH (RSOH)
Loss of Frame	
B1 BIP	
Out of Frame alarm	

### Line/MSOH Alarms

SONET (Line)	SDH (MSOH)
AIS-L	MS-AIS
RDI-L	MS-RDI
B2 BIP	B2 BIP
REI-L	MS-REI

### Path/HP Alarms

SONET (Path)	SDH (HP)
AIS-P	AU-AIS
LOP-P	AU-LOP
RDI-P	HP-RDI
UNEQ-P	HP-UNEQ
B3 BIP	B3 BIP
REI-P	HP-REI
PLM	PLM
All Ones	All Ones
Pointer Adjustments	Pointer Adjustments
New Pointers	New Pointers

- Status LED display for each alarm shows No Error (Green), History (Yellow) and Error (Red) for easy identification
- Count and seconds displayed for each alarm
- User selectable SONET or SDH terminology

Section					RSOH				
Alarms	Status	Seconds	Count		Alarms	Status	Seconds	Count	
Loss Of Frame	●	0	-		Loss Of Frame	●	0	-	
B1 BIP	●	0	0		B1 BIP	●	0	0	
Out Of Frame	●	0	-		Out Of Frame	●	0	-	
Line					MSOH				
Alarms	Status	Seconds	Count		Alarms	Status	Seconds	Count	
AIS-L	●	0	-		MS-AIS	●	0	-	
RDI-L	●	0	-		MS-RDI	●	0	-	
B2 BIP	●	0	0		B2 BIP	●	0	0	
REI-L	●	0	0		MS-REI	●	0	0	
Path					HP				
Alarms	Status	Seconds	Count		Alarms	Status	Seconds	Count	
AIS-P	●	0	-		AU-AIS	●	0	-	
LOP-P	●	0	-		AU-LOP	●	0	-	
RDI-P	●	0	-		HP-RDI	●	0	-	
UNEQ-P	●	0	-		HP-UNEQ	●	0	-	
B3 BIP	●	0	0		B3 BIP	●	0	0	
REI-P	●	0	0		HP-REI	●	0	0	
PLM	●	0	-		PLM	●	0	-	
All Ones	●	0	-		All Ones	●	0	-	
Pointer Adjustments	●	0	0		Pointer Adjustments	●	0	0	
New Pointers	●	0	0		New Pointers	●	0	0	

Figure: SONET/SDH Alarms

## Alarms/Error Monitoring (Contd.)

- Monitor and report alarm for Tx/Rx clock frequency and the frequency deviation (in ppm)
- Monitor and report alarms for SFP power (Tx/Rx power) and SFP temperature, including the SFP power/temperature alarm and warning thresholds, read from the SFP itself

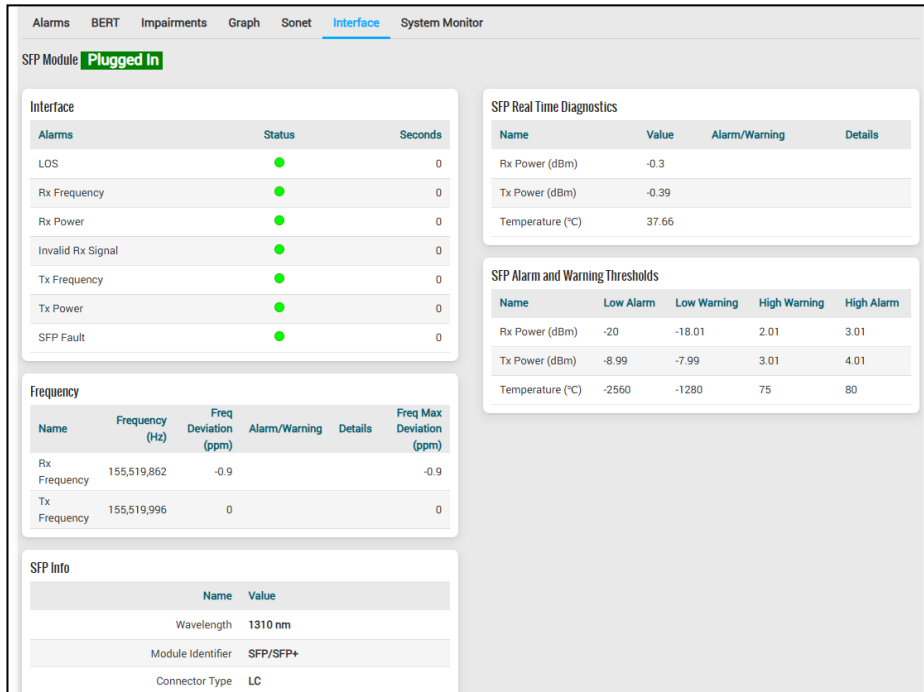

Figure: Monitor and Report Alarms

- Summary of the alarms for all ports, to let user know all the port status.

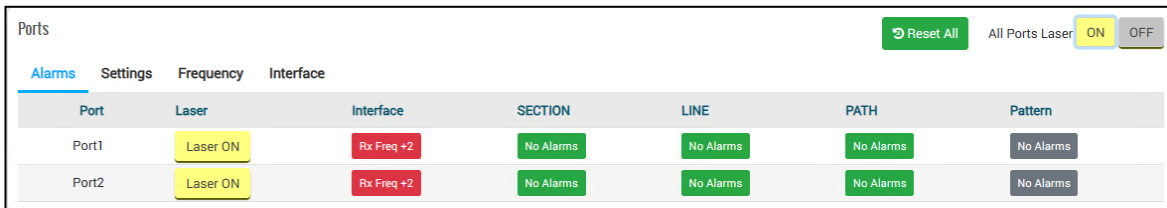

Figure: Port Status

- Different colors for alarms summary for easy identification of problems - Red (Alarm Active), Yellow (Alarm History) and Green (No Alarms)

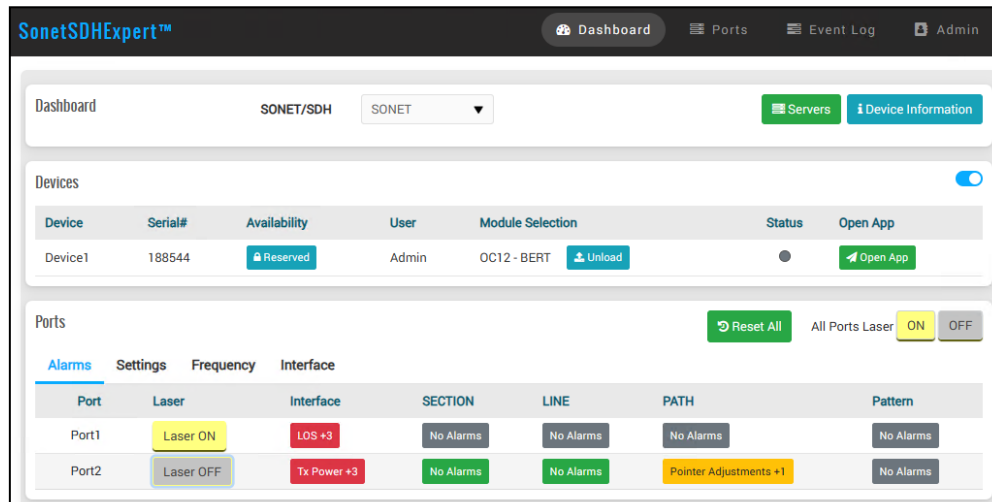

Figure: Alarms Summary with Errors



## Record and Playback application

SonetExpert™ provides two types of Error Insertion –**Bit Error Insertion** and **BIP Error Insertion**. Bit Error insertion allows inserting Bit Errors into the outgoing Tx traffic. BIP (Bit Interleaved Parity) Error insertion allows sending packets with wrong B1, B2 and B3 value.

In both the Bit Error and BIP Error Insertion types, single as well as Rate Error Insertion is supported. Single error insertion allows user to manually introduce a single Bit/BIP error. Rate Error insertion allows the user to select a constant error rate, ranging from  $10^{-3}$  to  $10^{-9}$ , to be introduced into the outgoing stream.

Also, user can set the H1/H2 pointer value, as well as introduce negative and positive justification into the outgoing stream. Both Single as well as rate justification can be introduced.

- **Record Application**

- Capture on both ports simultaneously to a file on hard disk in GL's proprietary HDL format
- Capture PoS traffic (PPP packets), ATM traffic (ATM cells), or RAW SONET/SDH traffic (RAW SONET/SDH frames)
- Multiple Versatile filters (ex PPP, IP, UDP etc for PoS, VPI, VCI and other ATM Header fields for ATM) can be applied to incoming PoS/ATM traffic to capture only traffic of interest. Up to 16 hardware filters can be applied to each port. Hardware filters work at wire speed.
- Hardware timestamping of captured traffic
- Onboard 8GB of DDR3 RAM memory to temporarily store the captured traffic before transferring it to the PC. Out of this 8GB, 4GB is used for the Record application and 4GB for the Playback application
- Capture based on different criteria - Size, Number of frames etc.
- Split capture into multiple files, for easy handling of small size files
- Multiple Record instances supported in parallel

The screenshot displays the 'Record To File' application interface. At the top, there is a navigation bar with 'Dashboard', 'Ports', 'Application', 'Event Log', and 'Admin'. The main content area is divided into several sections:

- Record To File:** A sidebar on the left shows a task list with one entry: 'Recorder1 (Raw)'.
- Configuration:** The main area has tabs for 'Configuration' and 'Summary'. It includes a 'Select Record Type' dropdown set to 'RAW DATAPIPE' and a red 'STOP' button.
- Select Ports:** A table lists two ports:
 

Port Name	Port ID	Details
<input checked="" type="checkbox"/> Port1	0	<a href="#">Details</a>
<input type="checkbox"/> Port2	1	<a href="#">Details</a>
- Select File:** A text input field contains 'Test.hdl' and a file selection icon.
- Capture Size:** A dropdown menu is set to '2048' with a 'Size MBytes' label.
- Split Recording:** A toggle switch is currently turned off.
- Status:** A table showing the current state:
 

Name	Value
Status	Running
Running Time	00:00:01
Progress	34/2,048 MB (1.67%)
Failure Reason	
- Statistics:** A table showing performance metrics:
 

Name	Value
Disk Write Bytes/Sec	19,603,122
Disk Write Buffer Utilization	0
Packets Received	14,748
File Bytes Written	36,088,356

Figure: Record To File Application

## Record and Playback application (*Contd.*)

- **Playback Application**

- Playback from file (previously captured file) on both ports simultaneously
- Playback PoS traffic (PPP packets), ATM traffic (ATM cells), or RAW SONET/SDH traffic (RAW SONET/SDH frames)
- Playback on the same ports as captured, or playback on user selected ports
- **One shot playback** - stop playback, once end of file is reached or **Continuous playback** - start over from the beginning once end of file is reached
- Playback specified number of frames only and stop
- Supports multiple playback instances in parallel, but only when multiple devices are connected. For example, one instance can playback on one device, while another instance can playback on another device

The screenshot displays the 'Playback From File' configuration page in the SonetSDHExpert™ application. The page is divided into several sections:

- Tasks List:** A table on the left shows a single task named 'Playback1 (Raw)' with a delete icon.
- Configuration Panel:**
  - Buttons for 'Configuration' and 'Summary' are at the top.
  - 'Server1' is selected in a dropdown menu.
  - 'Select Playback Type' is set to 'RAW DATAPIPE'.
  - A red 'STOP' button is visible.
  - 'Select File' is set to 'Test.hdl'.
  - 'EOF' is selected as the playback mode.
- Playback Ports:**
  - Options: 'As Per File' (selected) and 'File to Port Mapping'.
  - Text: 'Frames will be transmitted as per the PortId recorded in each frame of the file.'
  - 'Unmatched Port Handling': Action to take when PortId in file does not match any physical/configured port.
  - 'Action': 'Drop Frame'.
- Status Table:**

Name	Value
Status	Running
Running Time	00:00:01
Progress	1,956/864,312 (0.23)%
Failure Reason	
- File Info Table:**

Name	Value
Frames In File	864,312
Ports In File	0
- Statistics Table:**

Name	Value
Tx Frames	1,956

Figure: Playback Application

# Protocol Analysis Applications

## ATM Analyzer

GL's OC-3/STM-1, OC-12/STM-4 ATM Analyzer is used to analyze and decode different ATM protocols like RAW ATM, AAL2 Protocols (CPS-SDU (Common Part Sublayer Service Data Unit)), SSSAR-SDU (Service Specific Segmentation and Reassembly Sublayer), and SSCS (Service Specific Convergence Sublayer), AAL5 (CPCS-Common Part Convergence Sublayer), UNI and others across U plane and C plane of UNI and NNI interface. The analyzer can also decode ATM frames constituting Classical IP over ATM, or CIP based networks, and traditional SS7 Stack (ISUP, SCCP, MAP, CAMEL(CAP) etc.) over ATM.

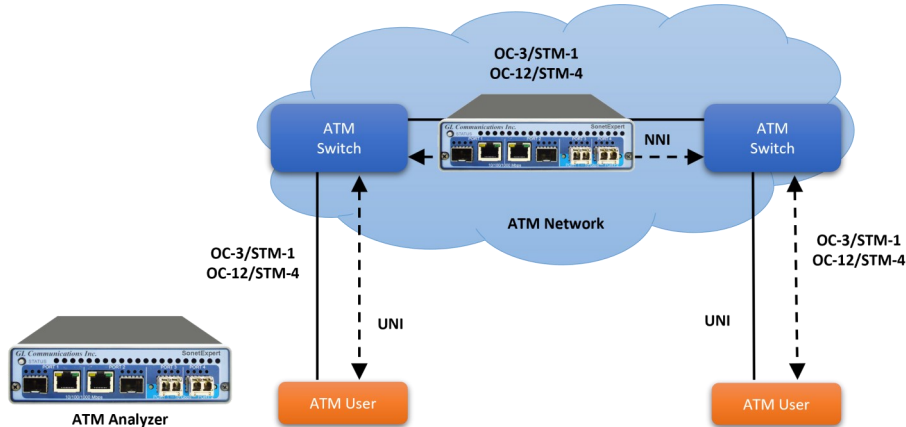

Figure: ATM in a OC-3 / STM-1 OC-12 / STM-4 Network

The ATM Analyzer can capture, decode, filter, and reassemble AAL-2 and AAL-5 frames in real-time, from within the ATM cells according to user defined VPI/VCI. The ATM Protocol Analyzer application is invoked from the application menu of GL's OC-3/STM-1, OC-12/STM-4 ATM Analyzer for real-time analysis. The analyzer displays Summary, Detail, Hex Dump, Statistics, and Call Detail Views in different panes. The Summary pane displays Dev#, Frame#, Time, Length, Error, VPI/VCI, PT and so on. User can select a frame in Summary View to analyze and decode each frame in the Detail View. The Hex Dump View displays the frame information in HEX and ASCII format.

Dev	TScout	Frame#	TIME (Relative)	Len	Error	Frame Type	VCI	VPI	PT	PID	Ether Type
						ATM	ATM	ATM	ATM	Multi Protocol Encapsulation	Multi Protocol Encapsulation
0	0	41207570	00:00:29.166894306	52		ATM-Cell	200	356	1		
0	0	41207571	00:00:29.166895026	52		ATM-Cell	200	356	1		
0	0	41207572	00:00:29.166895746	52		ATM-Cell	200	356	1		
0	0	41207573	00:00:29.166896364	52		ATM-Cell	200	356	1		
0	0	41207574	00:00:29.166897594	52		ATM-Cell	200	356	1		
0	0	41207575	00:00:29.166898320	52		ATM-Cell	200	356	1		
0	0	41207576	00:00:29.166898932	52		ATM-Cell	200	356	1		
0	0	41207577	00:00:29.166899652	52		ATM-Cell	200	356	1		
0	0	41207578	00:00:29.166900270	52		ATM-Cell	200	356	1		
0	0	41207579	00:00:29.166900990	52		ATM-Cell	200	356	1		

```

Device0 TScout=0 Frame=41207570 at 00:00:29.166894306 OK Len=52
ATM Frame Data
----- ATM Layer -----
0000 VPI          = 356 (00010110 0100....)
0001 VCI          = 200 (...0000 00001100 1000....)
0003 PT           = .....001. (1)
0003 CLP          = .....1 (1)
0004 HEC          = 00000110 (6)
Hex Dump of the Frame Data
16 40 0C 83 06 F7 44 5B 9D 65 32 F1 13 66 B5 0C      @ | -D[e2R f;
EF 59 C5 28 D4 D0 27 23 1B 5D C3 88 7C 98 40 68      iYA(OB'# ]A||@h
CF 4B 79 A2 95 DE 96 93 89 AB BB E0 76 13 36 38      IKyo|P|!!!|o;av 68
72 EA F0 08                                           rE8

```

Figure :Protocol Summary, Detail, and Hex Dump Views in ATM Protocol Analysis

## Protocol Analysis Applications (Contd.)

### PoS Analyzer

The PoS Analyzer captures a host of PoS protocols exchanged between the two nodes over SONET and provides useful analysis, which includes distribution of protocols, protocol fields, frame lengths, and frame status. User can obtain detailed analysis of the protocol and can perform various statistics measurements.

PoS Analyzer supports [Packet Data Analysis \(PDA\)](#) module, it is an outstanding tool for live monitoring of signaling and traffic over IP. PDA is distributed with GL's Packet Analyzers, allowing users to monitor live IP networks including capture, analysis, and reporting of every call in detail. Supported protocols include SIP, MEGACO, MGCP, H.323, SCCP, RANAP (UMTS IuCS), and GSM A. It can capture IP packets over different transmission lines, including IP, T1, E1, T3, E3, and OC-3 STM-1 / OC-12 STM-4. PDA then processes the captured packets, identifies, and segregates calls based on signaling and traffic parameters.

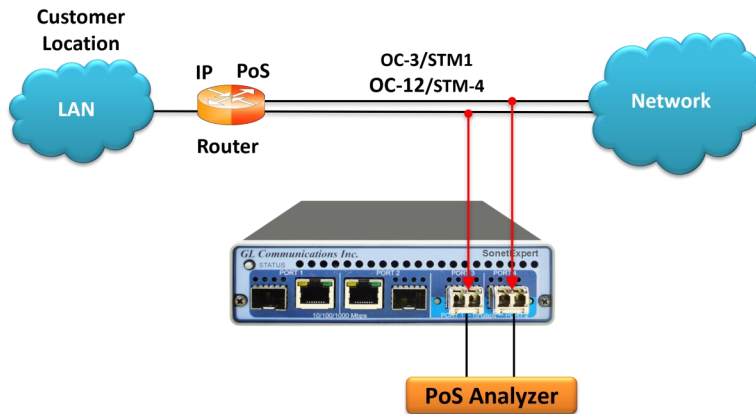

Figure: Analysis of PoS frames over OC-3 / STM-1 OC-12 / STM-4 Lines

The PoS analyzer application is invoked from the application menu of GL's OC-3/STM-1 OC-12/STM-4 Analyzer for real-time analysis. The analyzer displays Summary, Detail, Statistics, and Hex Dump Views in different panes. The Summary pane displays Dev#, Frame #, Time relative, Len, Error, Layer 3 protocol, LCP code, IPCP code, BCP code, PoS Message type, Source/Destination IP address, TCP Source/Destination Port, UDP Source/Destination Port, Message Type, and so on. The User can select a frame in Summary View to analyze and decode each frame in the Detail View. The Hex Dump View displays the frame information in HEX and ASCII format.

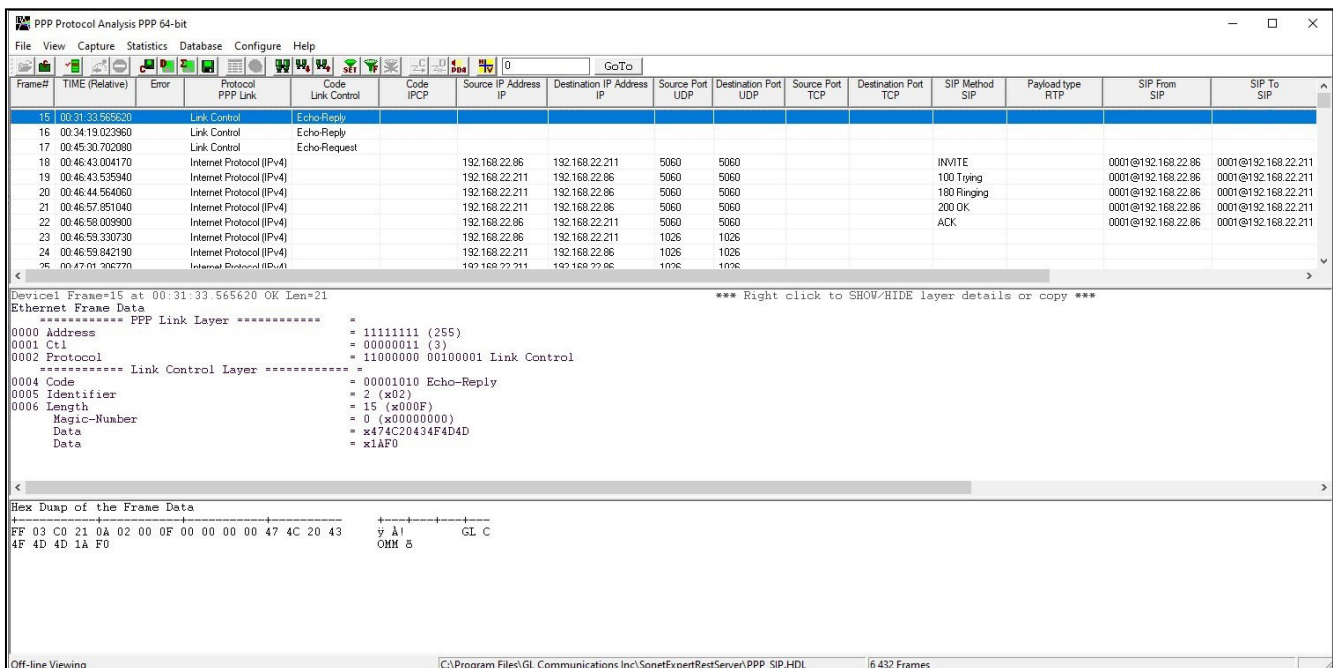

Figure: Protocol Summary, Detail, and Hex Dump Views in PoS Protocol Analysis

# Protocol Analysis Applications (Contd.)

## RAW Analyzer

GL's SonetExpert™ RAW Analyzer is used to analyze and decode RAW SONET/SDH packets.

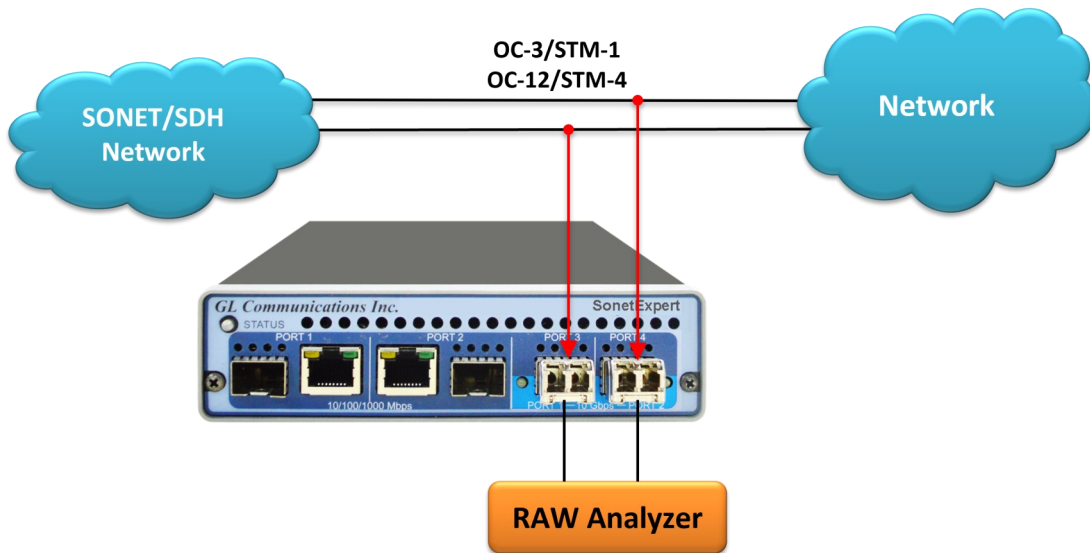

Figure: Analysis of RAW Packets over OC-3/STM-1 to OC-192/STM-64 Lines

The RAW analyzer application is invoked from the application menu of GL's OC-3 / STM-1 OC-12 / STM-4 Analyzer for real-time analysis.

The screenshot shows the Sonet Protocol Analysis SONET 64-bit application interface. It includes a menu bar (File, View, Capture, Statistics, Database, Configure, Help) and a toolbar. The main window displays a table of captured frames:

Device	Frame#	TIME (Difference)	Length (Bytes)	Error	WireLen
0	0	00:00:00.000000000	2430		
0	1	00:00:00.000124998	2430		
0	2	00:00:00.000125004	2430		
0	3	00:00:00.000124998	2430		
0	4	00:00:00.000124998	2430		
0	5	00:00:00.000125004	2430		
0	6	00:00:00.000124998	2430		
0	7	00:00:00.000124998	2430		
0	8	00:00:00.000125004	2430		
0	9	00:00:00.000124998	2430		

Below the table, the interface shows details for 'Device0 Frame#0 at 03:12:02.512233282 OK Len=2430'. It includes an Ethernet frame breakdown with headers (ST5-3c Layer) and payload bytes (1-87). A hex dump of the frame data is also visible, showing the raw hexadecimal values of the captured packet.

Figure: Protocol Summary, Detail, and Hex Dump Views in RAW Protocol Analysis

## SCAN Application

SonetExpert™ scans incoming SONET/SDH traffic, analyzes the frames, detects and reports the traffic structure of the incoming traffic down to the T1 E1 level. It identifies the various sub pipes within the main pipe, and also the entire structure of each sub pipe down to the T1 E1 level.

- Graphical display of the traffic structure for easy visualization
- Identifies and displays sub channels down to T1 E1 level
- Indicates Equipped (display channel details) and Unequipped sub channels in different colors for easy identification
- User selectable SONET or SDH terminology supported on both the ports independently

Below are the results of scanning incoming traffic on OC-192. The SCAN displays that the OC-192 contains four OC-48 pipes within, and display details of each of the four OC-48s in a separate tab.

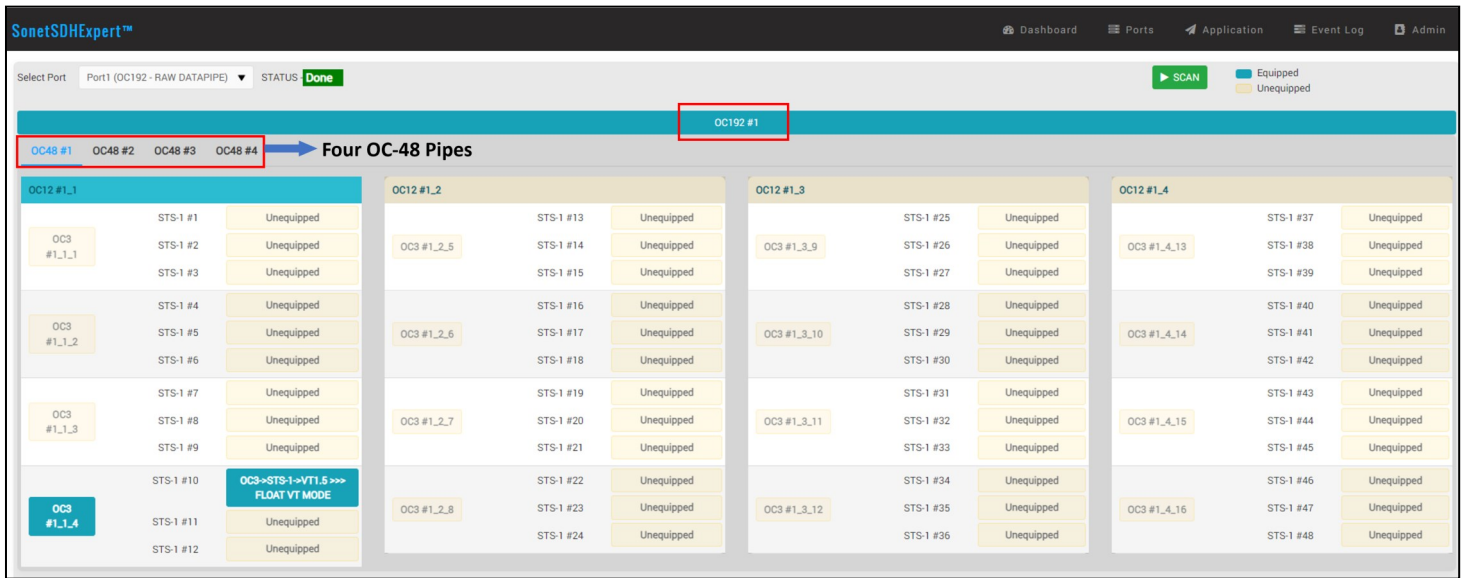

Figure: OC-48s in Separate Tab

### SCAN Application (Contd.)

- For each OC-48 further displays details of the OC-12s, and in turn details of the OC-3s within the OC-12s down to the STS-1 level
- For each STS-1, it display the details of traffic structure contained within the STS-1
- The equipped channels are marked as shown below

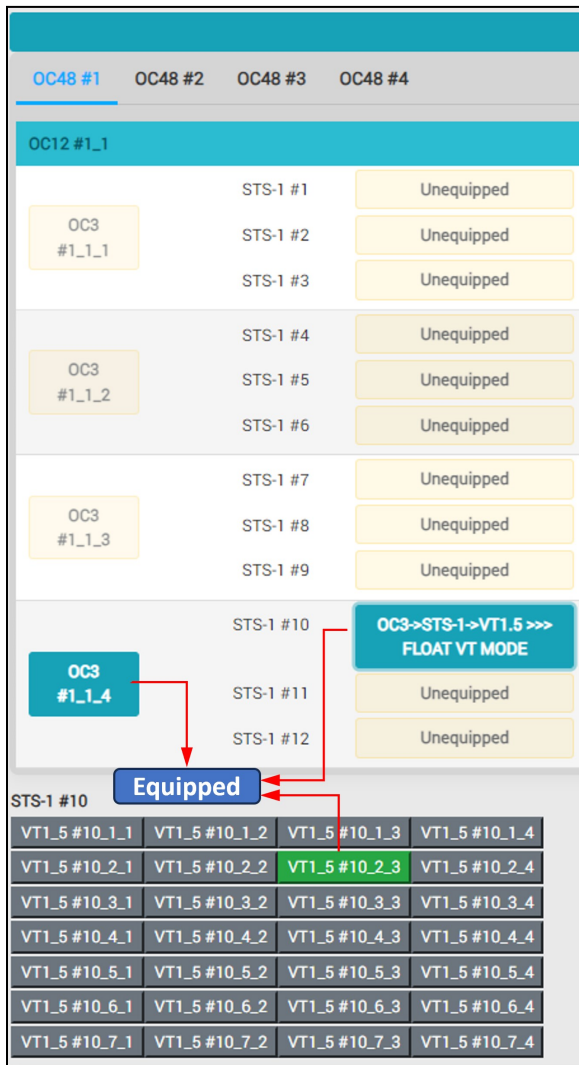

Figure: OC-192 with Substructure

In this scenario, OC-48#1 contains an equipped channel -> OC-12 #1 (OC-12 #1\_1) -> OC-3 #4 (OC-3#1\_1\_4) -> STS-1 #1 (STS #10 overall STS numbering). The STS-1 #1 is equipped channel, which contains VT1.5s within it. Upon clicking the substructure button, the detailed substructure will be displayed. It shows twenty eight VT1\_5 channels and within it the VT1\_5 on Row2, column 3 is equipped as shown in **Green**.

The SCAN result also supports concatenated format. The below displays the concatenated OC-192 traffic with a single pipe containing STS-192C signal.

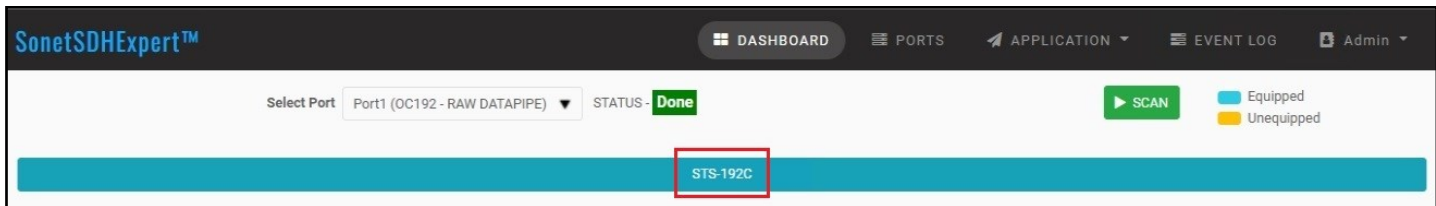

Figure: SCAN Results in Concatenated Format (OC-192)

# SCAN Application (Contd.)

The SCAN application provides option to change the terminology (SONET/SDH) at anytime. The below shows the SCAN result of SDH.

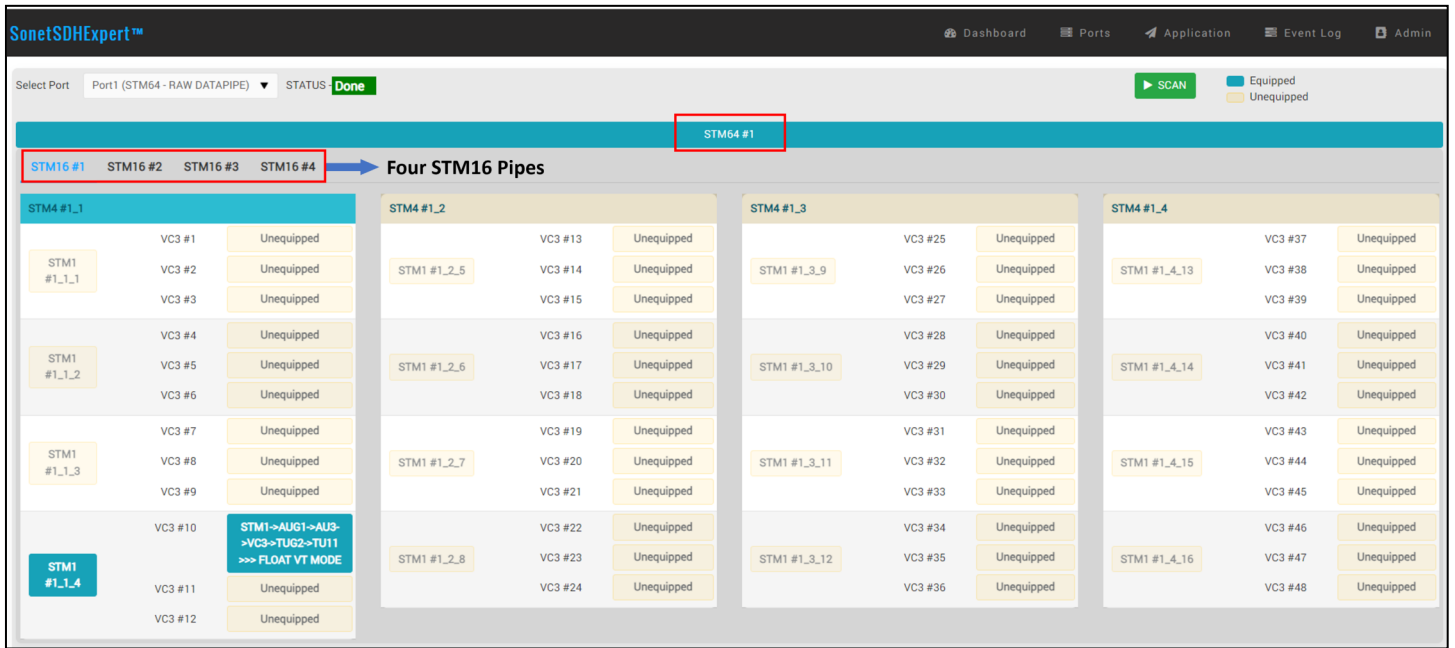

Figure: STM-16s in Separate Tab

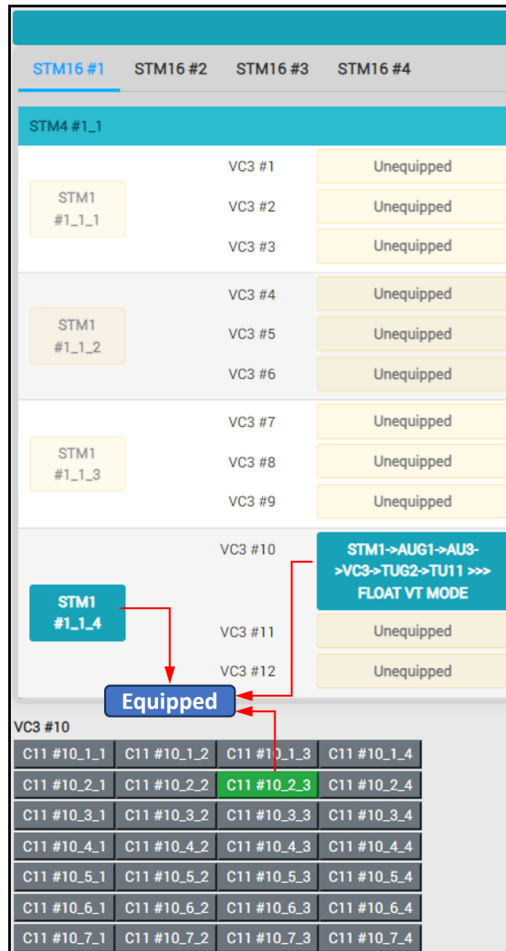

Figure: STM-64 with Substructure



## Hardware Specifications of SonetExpert™

SonetExpert™ contains four ports, out of which two ports (Optical Port 1 and Port 2) are designated for SONET/SDH Channelized and Unchannelized carrying many Channelized unframed/framed T1 or E1 streams, and Unchannelized RAW, PoS, and ATM streams for OC-3/STM-1 and OC-12/STM-4.

Connecting the optical SFPs to the fiber optic ports, the two ports (Port 1, Port 2) on the unit are available for OC-3/STM-1, OC-12/STM-4, OC-48/STM-16 and OC-192/STM-64 Unchannelized testing.

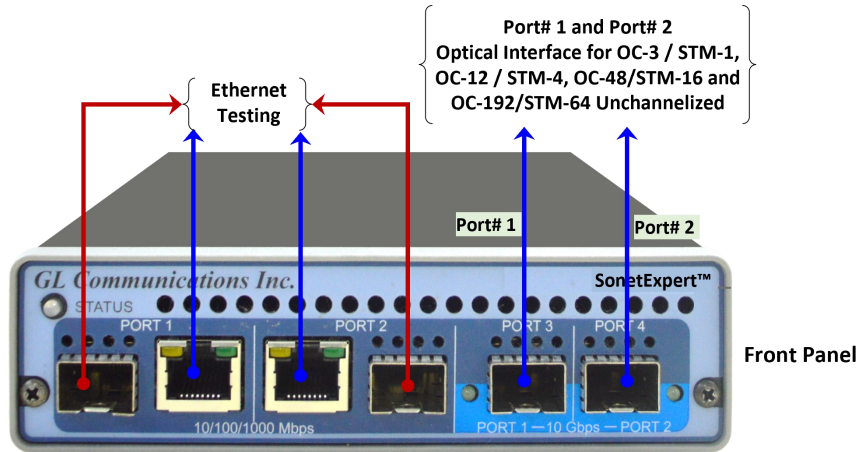

Figure: SonetExpert™ Hardware Unit (Front Panel)

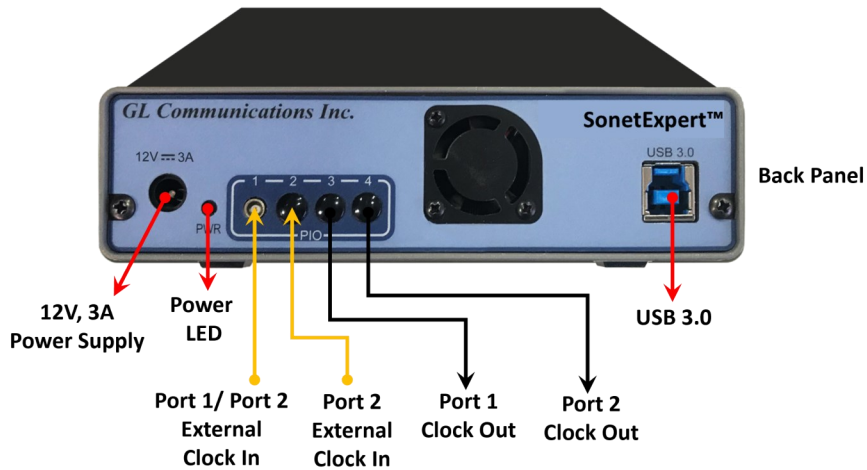

Figure: SonetExpert™ Hardware Unit with External Clock Feature (Back Panel)

Interfaces	<ul style="list-style-type: none"> <li>• 2 x Unchannelized Ports (OC-3 / STM-1, OC-12 / STM-4, OC-48/STM-16 and OC-192/STM-64)</li> <li>• Single Mode or Multi Mode Fiber SFP support with LC connector</li> <li>• USB 3.0 Port</li> <li>• External Clock: Input Port 1, Port 2 and Output Port 1, Port 2</li> </ul>
Dimensions	<ul style="list-style-type: none"> <li>• Length: 8.45 in. (214.63 mm)</li> <li>• Width: 5.55 in. (140.97 mm)</li> <li>• Height: 1.60 in (40.64 mm)</li> </ul>
Power	<ul style="list-style-type: none"> <li>• +12 Volts (Medical Grade), 3 Amps (For portable units having serial number ≥ 188400)</li> </ul>

## SonetExpert™ mTOP™ 1U Rack Solution Specifications

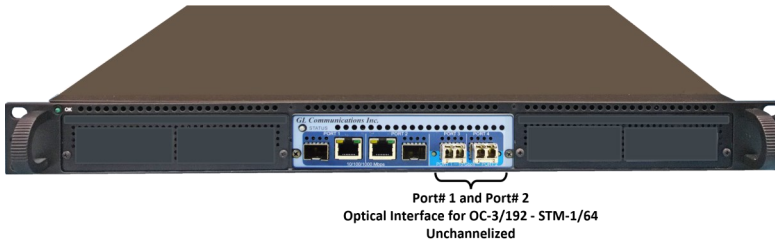

Figure: SonetExpert™ mTOP™ 1U rack solution (Front Panel View)



Figure: SonetExpert™ mTOP™ 1U rack solution (Back Panel View)

<b>Physical Specifications</b>	<ul style="list-style-type: none"> <li>• Height: 1U Rack</li> <li>• Length: 16 Inches</li> <li>• Width: 19 Inches</li> </ul>
<b>SonetExpert™ interfaces (1 unit)</b>	<ul style="list-style-type: none"> <li>• Two-Unchannelized Ports (OC-3/STM-1/, OC-12/STM-4, OC-48/STM-16 and OC-192/STM-64)</li> <li>• Single Mode or Multi Mode Fiber SFP support with LC connector</li> </ul>
<b>SBC Specifications</b>	<ul style="list-style-type: none"> <li>• Embedded SBC, 1x SonetExpert™</li> <li>• Intel Core i3 or optional i7 NUC Equivalent, Windows® 11 64-bit Pro operating system</li> <li>• USB 2.0 and USB 3.0 Ports, ATX Power Supply</li> <li>• USB Type C ports, Ethernet 2.5GigE port</li> <li>• 256 GB Hard drive, 16GB Memory (Min)</li> <li>• Two HDMI ports for display</li> </ul>
<b>Order information</b>	<ul style="list-style-type: none"> <li>• MT001/MT001E - 1U mTOP rack with SBC (Intel Core i7)</li> <li>• SonetExpert™ Unchannelized Analyzer part numbers as required (OC-3/STM-1, OC-12/STM-4, OC-48/STM-16 and OC-192/STM-64)</li> </ul>

## SonetExpert™ mTOP™ Probe Specifications

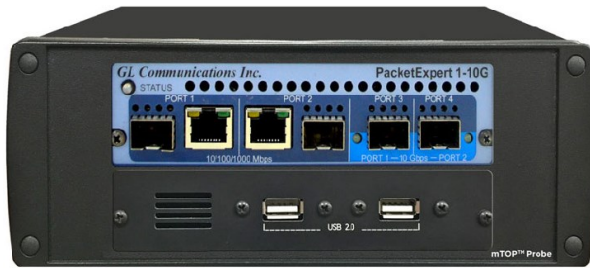

Figure: SonetExpert™ mTOP™ Probe unit (Front Panel View)



Figure: SonetExpert™ mTOP™ Probe unit (Rear Panel View)

<b>Physical Specifications</b>	<ul style="list-style-type: none"> <li>• Height: 3.0 Inches (76.2 mm)</li> <li>• Length: 10.4 Inches (264.16 mm)</li> <li>• Width: 8.4 Inches (213.36 mm)</li> </ul>
<b>SonetExpert™ interfaces</b>	<ul style="list-style-type: none"> <li>• 4x 1G Base-X Optical OR 10/100/1000 Base-T Electrical</li> <li>• 2x 10G Base-SR, -LR -ER Optical option</li> <li>• 2 x 100 Mbps Base-FX optical interface</li> <li>• Single Mode or Multi Mode Fiber SFP support with LC connector</li> <li>• Optional 4-Port SMA Jack Trigger Board (TTL Input/Output)</li> <li>• External USB based Wi-Fi adaptor</li> </ul>
<b>External Power Supply</b>	<ul style="list-style-type: none"> <li>• +12 Volts (Medical Grade), 3 Amps</li> </ul>
<b>SBC Specifications</b>	<ul style="list-style-type: none"> <li>• Intel Core i3 or optional i7 NUC Equivalent, Windows® 11 64-bit Pro Operating System</li> <li>• USB 2.0 or and USB 3.0 Ports, ATX Power Supply</li> <li>• USB Type C ports, Ethernet 2.5GigE port</li> <li>• 256 GB Hard drive, 16GB Memory (Min)</li> <li>• Two HDMI ports for display</li> </ul>

## Buyer's Guide

Item No	Product Description
<a href="#">SEU100</a>	SonetExpert™ Dual OC-3/12 STM-1/4 USB Unit <b>Accessories</b> Includes OC-3/OC-12/STM-1/STM-4 SFPs (customer preference of MM or SM) USB Cable 3.0 (1) Power adapter +12 Volts, 3 Amps (1)
<a href="#">SEU901</a>	SonetExpert™ Unchannelized RAW BERT for OC-3/STM-1 and OC-12/STM-4 Rates
<a href="#">SEU902</a>	SonetExpert™ Unchannelized RAW BERT for OC-3/STM-1, OC-12/STM-4, OC-48/STM-16, OC-192/STM-64 Rates
<a href="#">SEU300</a>	SonetExpert™ Unchannelized OC-3/STM-1 and OC-12/STM-4 ATM Monitor, BERT, Tx/Rx Test
<a href="#">SEU301</a>	SonetExpert™ Unchannelized OC-3/STM-1 and OC-12/STM-4 PoS Monitor, BERT, Tx/Rx Test
<a href="#">SEU302</a>	SonetExpert™ Unchannelized ATM Record Playback for OC-3/STM-1 and OC-12/STM-4
<a href="#">SEU303</a>	SonetExpert™ Unchannelized PoS Record Playback for OC-3/STM-1 and OC-12/STM-4
<a href="#">SEU304</a>	SonetExpert™ Unchannelized ATM Protocol Analysis for OC-3/STM-1 and OC-12/STM-4
<a href="#">SEU305</a>	SonetExpert™ Unchannelized PoS Protocol Analysis for OC-3/STM-1 and OC-12/STM-4
<a href="#">SEU503</a>	SonetExpert™ Unchannelized RAW Record Playback for OC-3/STM-1 and OC-12/STM-4 includes SCAN feature
<a href="#">SEU315</a>	SonetExpert™ Unchannelized Packet Data Analysis (PDA) for PoS

Item No	Optional Applications
<a href="#">SEU110</a>	SonetExpert™ Upgrade to PXN100
<a href="#">SEU120</a>	SonetExpert™ Upgrade to PXN101
<a href="#">PXN100</a>	PacketExpert™ 10GX
<a href="#">PXN101</a>	10G option for PXN100
<a href="#">PXN00</a>	Optical Multiport Tap/Repeater
<a href="#">PXN01</a>	Multi-rate Multimode SFPs and FO Cables
<a href="#">PXN02</a>	Multi-rate Singlemode SFPs and FO Cables

**Note:** PCs which include GL hardware/software require Intel or AMD processors for compliance.

For more information, visit [SonetExpert™ Unchannelized Analyzer](#) webpage.